

M12-A-5

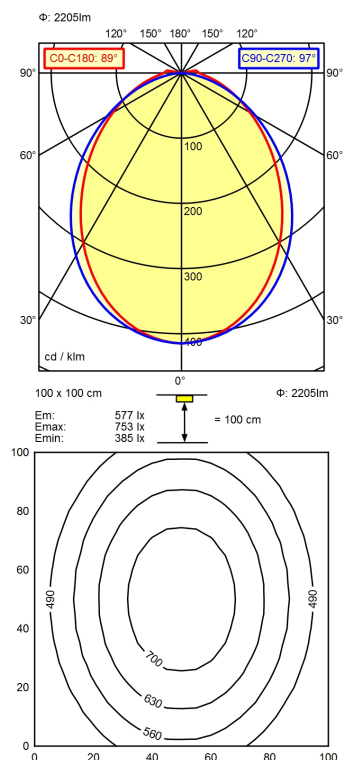

light source
work equipment
connected load
power consumption
luminous flux
luminous efficiency
light type/-color
colour temperatur
color rendering index
light distribution
beam angle
chromaticity tolerance LED
glare control
system of protection
class of protection
technology
operation
housing
cover
weight (net)
mains lead
design
fastening
dimension
decorative contrast side parts
special features

LED
without
22-26 V, DC
env. 17,5 W
approx. 2.205 lm
approx. 126 lm/W
cold white
approx. 5.000 K
CRI > 80
direct
89° / 97°
< 4 SDCM
screen
IP 54
III
multi-stage switchable; no notice
external
aluminium/plastic; anodised, painted; aluminium
coloured anodised
Acrylic (PMMA); satine
ca. 0,447; KG
built-in plug; M12-A-5
mounted version
bracket
A=1035mm, C=990mm, C1=1020mm
natural silver anodised
ADVANCED package